

SOFÁS Y BUTACAS







PUZZLE

Módulo con respaldo



Tapicería	Medidas (axfxh)	Referencia	Precio
Tela	75x75x71 cm	PPUZ01	415 €
Simil-Piel	75x75x71 cm	PPUZ01	443 €

Especificaciones

De serie con patas metálicas redondas en color negro (N) o blanco (B). Otras opciones en página 8.

Módulo esquina con respaldos



Tapicería	Medidas (axfxh)	Referencia	Precio
Tela	75x75x71 cm	PPUZ02	489 €
Simil-Piel	75x75x71 cm	PPUZ02	517 €

Especificaciones

De serie con patas metálicas redondas en color negro (N) o blanco (B). Otras opciones en página 8.

Módulo doble con 1 o 2 respaldos



Tapicería	Medidas (axfxh)	Referencia	Precio
Módulo doble con 1 respaldo			
Tela	150x75x71 cm	PPUZ03	639 €
Simil-Piel	150x75x71 cm	PPUZ03	689 €

Módulo doble con 2 respaldo

Tela	150x75x71 cm	PPUZ04	712 €
Simil-Piel	150x75x71 cm	PPUZ04	763 €

Especificaciones

De serie con patas metálicas redondas en color negro (N) o blanco (B). Otras opciones en página 8.

Módulo doble esquina



Tapicería	Medidas (axfxh)	Referencia	Precio
Tela	150x75x71 cm	PPUZ05D/I	623 €
Simil-Piel	150x75x71 cm	PPUZ05D/I	669 €

Especificaciones

De serie con patas metálicas redondas en color negro (N) o blanco (B). Otras opciones en página 8.
Indicar posición de los respaldos de esquina, a mano derecha o a mano izquierda.

Módulo doble esquina + respaldo



Tapicería	Medidas (axfxh)	Referencia	Precio
Tela	150x75x71 cm	PPUZ06D/I	782 €
Simil-Piel	150x75x71 cm	PPUZ06D/I	838 €

Especificaciones

De serie con patas metálicas redondas en color negro (N) o blanco (B). Otras opciones en página 8.
Indicar posición de los respaldos de esquina, a mano derecha o a mano izquierda.

Módulo doble esquina con respaldos



Tapicería	Medidas (axfxh)	Referencia	Precio
Tela	150x75x71 cm	PPUZ07	847 €
Simil-Piel	150x75x71 cm	PPUZ07	909 €

Especificaciones

De serie con patas metálicas redondas en color negro (N) o blanco (B). Otras opciones en página 8.

PUZZLE

Puff 1 plaza



Tapicería	Medidas (axfxh)	Referencia	Precio
Tela	75x75x40 cm	PPUZ08	257 €
Simil-Piel	75x75x40 cm	PPUZ08	275 €

Especificaciones

De serie con patas metálicas redondas en color negro (N) o blanco (B). Otras opciones en página 8.

Puff 2 plazas



Tapicería	Medidas (axfxh)	Referencia	Precio
Tela	150x75x40 cm	PPUZ09	394 €
Simil-Piel	150x75x40 cm	PPUZ09	425 €

Especificaciones

De serie con patas metálicas redondas en color negro (N) o blanco (B). Otras opciones en página 8.

Elementos opcionales



Color	Referencia	Precio
<u>Juego de 4 patas metálicas cuadradas.</u> Negro (N) o blanco (B)	PPUZ10	40 €
<u>Bandeja metálica.</u> Negro (N) o blanco (B)	PPUZ11	25 €

Muestrario TELA Basic.



Muestrario TELA Cosvi.



Muestrario SIMIL-PIEL.

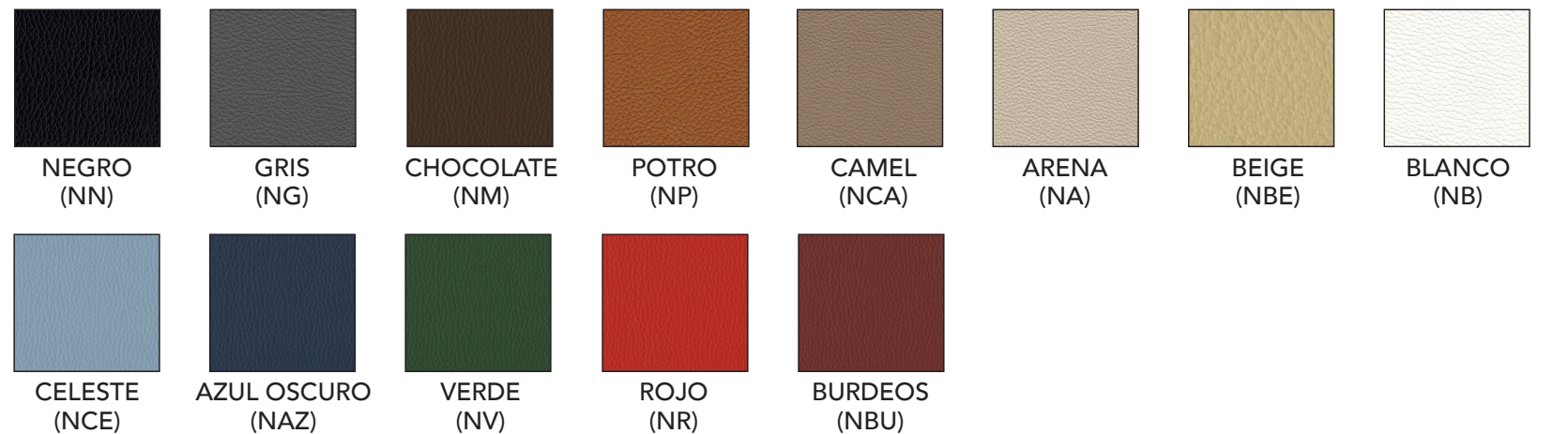



SINGLE / DUO

1 Plaza



Tapicería	Medidas (axfxh)	Referencia	Precio
Sin brazos			
Tela	61x66x70 cm	PSIN1P	217 €
Simil-Piel	61x66x70 cm	PSIN1P	239 €
Con brazos plata			
Tela	68x66x70 cm	PSIN1B2P	289 €
Simil-Piel	68x66x70 cm	PSIN1B2P	312 €
Con brazos cromados			
Tela	68x66x70 cm	PSIN1B2C	372 €
Simil-Piel	68x66x70 cm	PSIN1B2C	395 €

2 Plazas



Tapicería	Medidas (axfxh)	Referencia	Precio
Sin brazos			
Tela	120x66x70 cm	PDUO2P	384 €
Simil-Piel	120x66x70 cm	PDUO2P	428 €
Con brazos plata			
Tela	127x66x70 cm	PDUO2B2P	456 €
Simil-Piel	127x66x70 cm	PDUO2B2P	499 €
Con brazos cromados			
Tela	127x66x70 cm	PDUO2B2C	540 €
Simil-Piel	127x66x70 cm	PDUO2B2C	584 €

Puff de 1 y 2 plazas



Tapicería	Medidas (axfxh)	Referencia	Precio
1plaza			
Tela	61x50x45 cm	PSINPUF	196 €
Simil-Piel	61x50x45 cm	PSINPUF	210 €
2 plazas			
Tela	120x50x45 cm	PDUOPUF	246 €
Simil-Piel	120x50x45 cm	PDUOPUF	274 €

Muestrario TELA Basic.

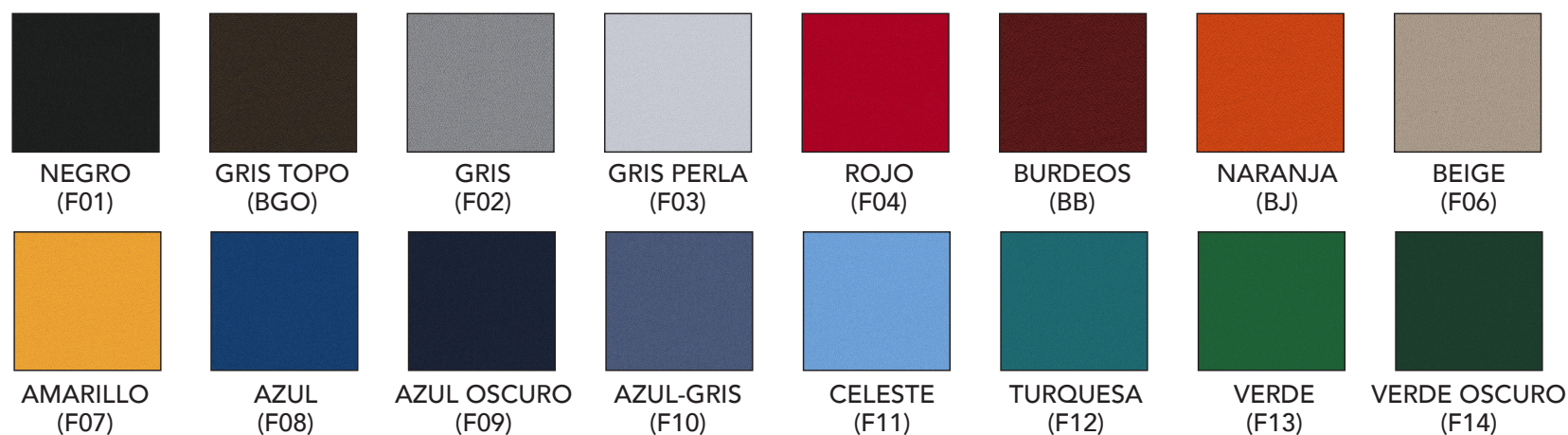

Muestrario TELA Cosvi.



Muestrario SIMIL-PIEL.

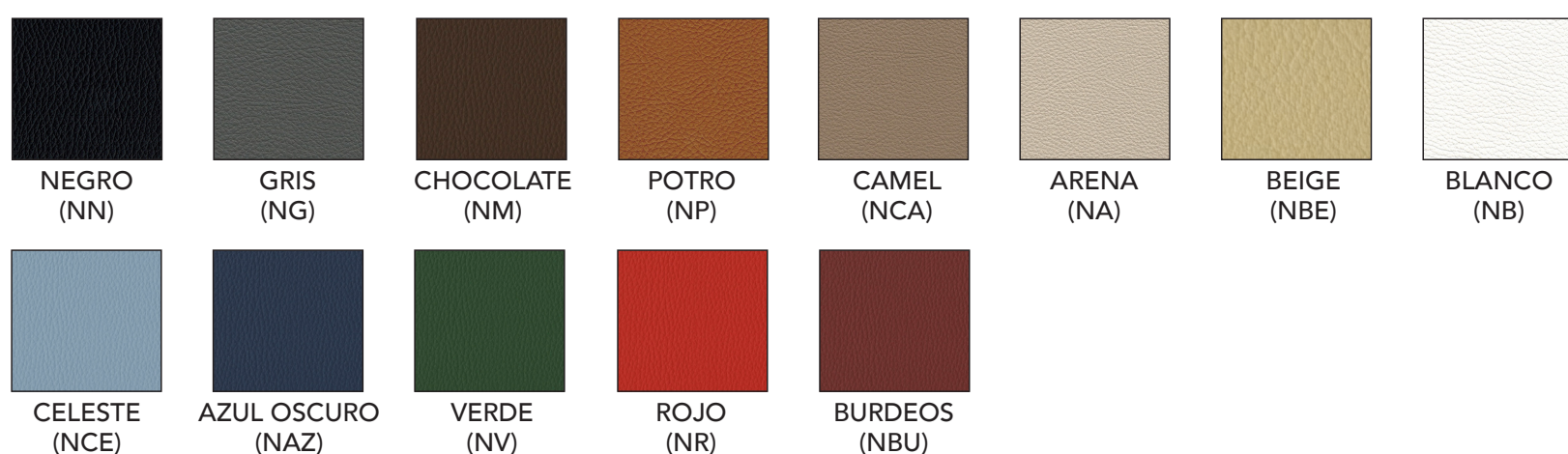



PARK

1 Plaza



Tapicería	Medidas (axfxh)	Referencia	Precio
<u>Sin brazos</u>			
Tela	62x74x82 cm	UPARKC	179 €
Simil-Piel	62x74x82 cm	UPARKC	214 €
<u>Con brazos</u>			
Tela	70x74x82 cm	UPARKBC	279 €
Simil-Piel	70x74x82 cm	UPARKBC	315 €

Muestrario TELA

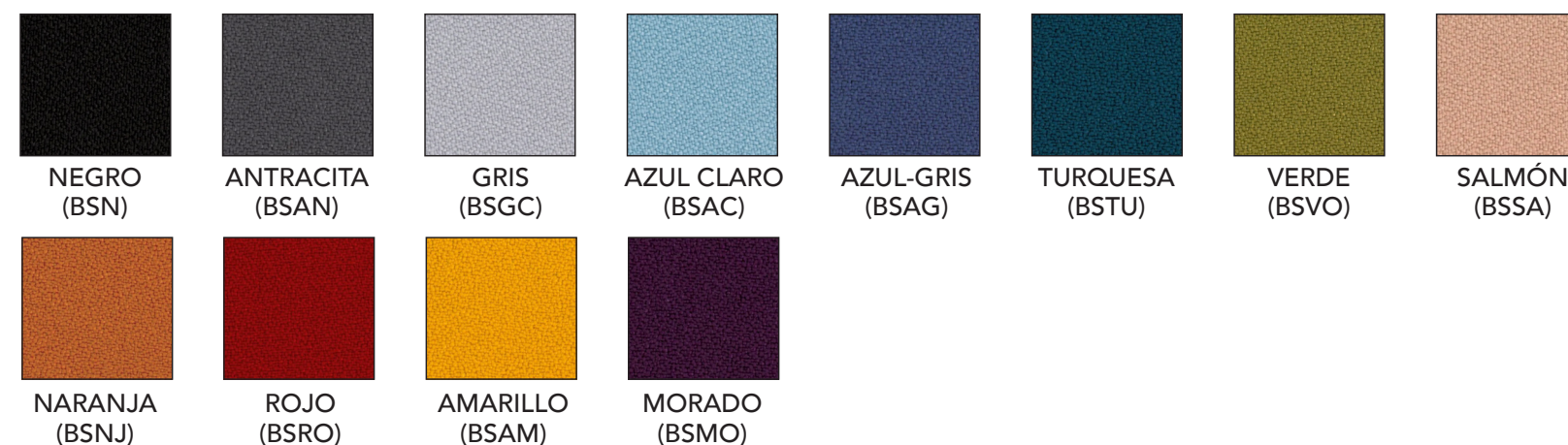

2 Plazas



Tapicería	Medidas (axfxh)	Referencia	Precio
<u>Sin brazos</u>			
Tela	120x74x82 cm	UPARKC2	306 €
Simil-Piel	120x74x82 cm	UPARKC2	369 €
<u>Con brazos</u>			
Tela	128x74x82 cm	UPARKBC2	405 €
Simil-Piel	128x74x82 cm	UPARKBC2	469 €

Muestrario SIMIL-PIEL



3 Plazas



Tapicería	Medidas (axfxh)	Referencia	Precio
<u>Sin brazos</u>			
Tela	180x74x82 cm	UPARKC3	456 €
Simil-Piel	180x74x82 cm	UPARKC3	549 €
<u>Con brazos</u>			
Tela	188x74x82 cm	UPARKBC3	555 €
Simil-Piel	188x74x82 cm	UPARKBC3	649 €



JAPAN

1 Plaza con base cruzada



Tapicería	Medidas (axfxh)	Referencia	Precio
Tela	70x64x77 cm	PJAP1	444 €
Simil-Piel	70x64x77 cm	PJAP1	463 €

Especificaciones

Base cruzada en color negro (N), blanco (B) o cromado (C).

2 Plazas con base cruzada



Tapicería	Medidas (axfxh)	Referencia	Precio
Tela	116x64x77 cm	PJAP2	587 €
Simil-Piel	116x64x77 cm	PJAP2	617 €

Especificaciones

Base cruzada en color negro (N), blanco (B) o cromado (C).

3 Plazas con base cruzada

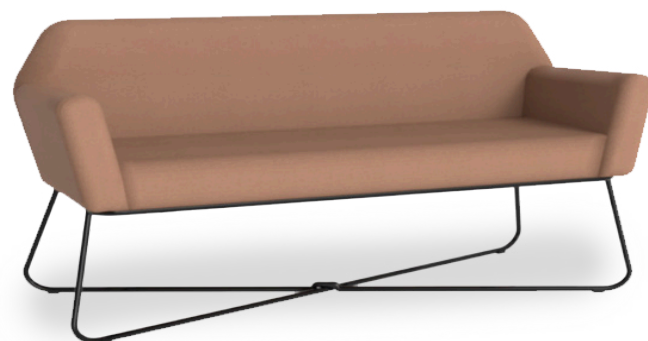

Tapicería	Medidas (axfxh)	Referencia	Precio
Tela	151x64x77 cm	PJAP3	738 €
Simil-Piel	151x64x77 cm	PJAP3	777 €

Especificaciones

Base cruzada en color negro (N), blanco (B) o cromado (C).

1 Plaza con base de 4 radios



Tapicería	Medidas (axfxh)	Referencia	Precio
Tela	70x64x76-85 cm	PJAP1PGC	534 €
Simil-Piel	70x64x76-85 cm	PJAP1PGC	556 €

Especificaciones

Base giratoria de aluminio pulido con elevación en altura.

Cojín independiente a juego



Tapicería	Medida	Referencia	Precio
Tela	Ø30 cm	PJAPCPJ	24 €
Simil-Piel	Ø30 cm	PJAPCPJ	28 €



JAPAN Muestrario



Muestrario TELA Basic.

NEGRO (F01)	GRIS TOPO (BGO)	GRIS (F02)	GRIS PERLA (F03)	ROJO (F04)	BURDEOS (BB)	NARANJA (BJ)	BEIGE (F06)
AMARILLO (F07)	AZUL (F08)	AZUL OSCURO (F09)	AZUL-GRIS (F10)	CELESTE (F11)	TURQUESA (F12)	VERDE (F13)	VERDE OSCURO (F14)

Muestrario TELA Cosvi.

GRIS (CG)	GRIS CLARO (CGC)	TOPO (CTO)	MARRÓN (CMA)	POWDER (CPO)	DAK BEIGE (CDB)	BEIGE (CBE)	TURQUESA (CT)
BERENJENA (CBJ)	CORAL (CCO)	ROSA (CRO)					

Muestrario SIMIL-PIEL.

NEGRO (NN)	GRIS (NG)	CHOCOLATE (NM)	POTRO (NP)	CAMEL (NCA)	ARENA (NA)	BEIGE (NBE)	BLANCO (NB)
CELESTE (NCE)	AZUL OSCURO (NAZ)	VERDE (NV)	ROJO (NR)	BURDEOS (NBU)			

Muestrario estructura base cruzada. Otros colores disponibles, consultar

NEGRO (N)	BLANCO (B)	CROMADO (C)



CUBIK

1 Plaza



Tapicería	Medidas (axfxh)	Referencia	Precio
Base negra (N) o blanca (B)			
Tela	59x62x75 cm	PCUB1P	337 €
Simil-Piel	59x62x75 cm	PCUB1P	359 €
Base cromada			
Tela	59x62x75 cm	PCUB1PC	369 €
Simil-Piel	59x62x75 cm	PCUB1PC	392 €

Muestrario TELA Basic.



2 Plazas



Tapicería	Medidas (axfxh)	Referencia	Precio
Base negra (N) o blanca (B)			
Tela	120x62x75 cm	PCUB2P	426 €
Simil-Piel	120x62x75 cm	PCUB2P	459 €
Base cromada			
Tela	120x62x75 cm	PCUB2PC	489 €
Simil-Piel	120x62x75 cm	PCUB2PC	522 €

Muestrario TELA Cosvi.



Mesas Cubik



Descripción			
Base perimetral con 4 patas negras (N), blancas (B) o cromadas (C) con tablero blanco (B), roble (RB) o nogal (NL).			
Medidas (axfxh)	Color patas	Referencia	Precio
120x62x36 cm	Negro o blanco	PCUBMC	163 €
120x62x36 cm	Cromadas	PCUBMC	218 €
62x62x36 cm	Negro o blanco	PCUBMR	129 €
62x62x36 cm	Cromadas	PCUBMR	158 €

Muestrario SIMIL-PIEL.

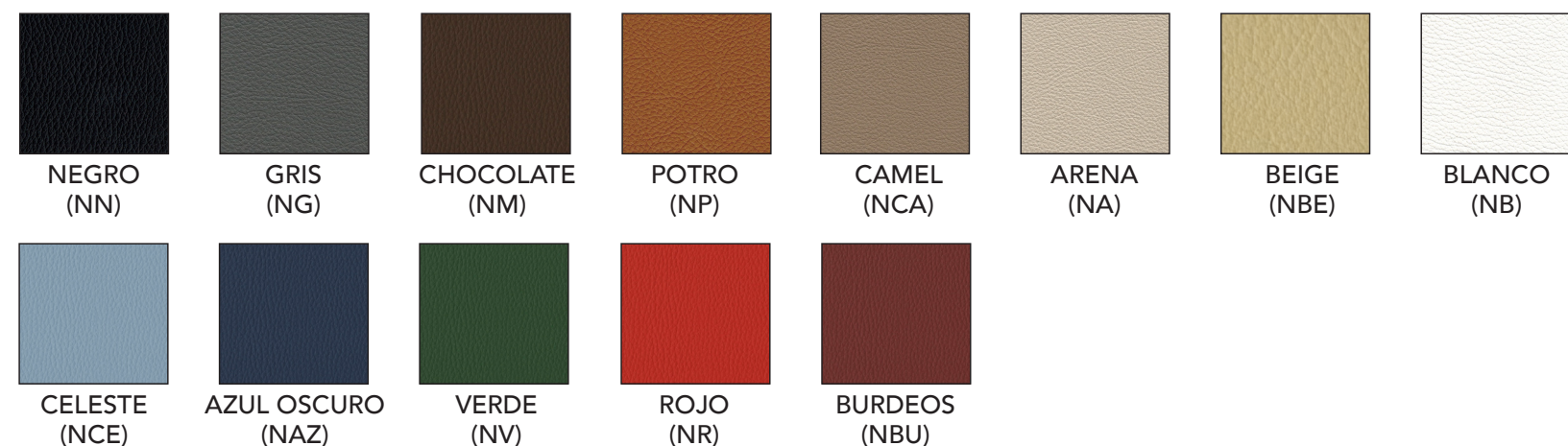



M900 PLUS

1 Plaza



Tapicería	Medidas (axfxh)	Referencia	Precio
Simil-Piel	79x75x68 cm	CADM9P1	394 €

Mostrario SIMIL-PIEL. Otros colores disponibles, consultar

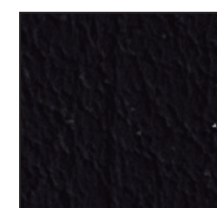

NEGRO
(RNE)



GRAFITO
(RGR)

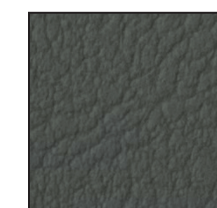

GRIS
(RG)

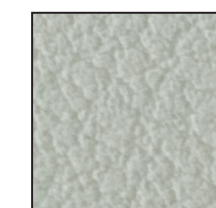

GRIS CLARO
(RGC)



TAUPE
(RTA)



BEIGE
(RBE)



ARENA
(RAR)

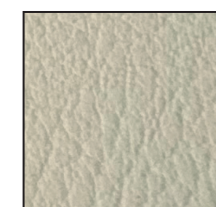

BLANCO
(RBW)

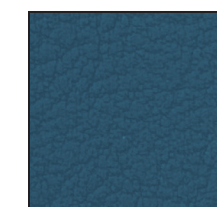

AZUL
(RAZ)

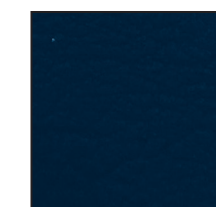

AZUL OSCURO
(RAO)

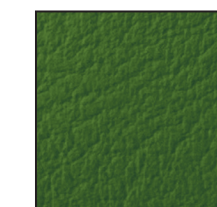

VERDE O.
(RVO)

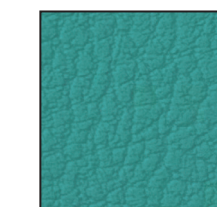

VERDE J.
(RVJ)

2 Plazas



Tapicería	Medidas (axfxh)	Referencia	Precio
Simil-Piel	131x75x68 cm	CADM9P2	532 €



VERDE
(RVT)



MELOCOTÓN
(RML)



TERRACOTA
(RTE)



ROJO
(RRO)

3 Plazas



Tapicería	Medidas (axfxh)	Referencia	Precio
Simil-Piel	180x75x68 cm	CADM9P3	669 €



M900

1 Plaza



Tapicería	Medidas (axfxh)	Referencia	Precio
Simil-Piel	79x75x68 cm	CADM901	409 €

Muestrario estructura y patas



NEGRO (N)

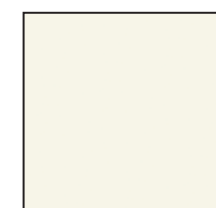

BLANCO (B)

2 Plazas



Tapicería	Medidas (axfxh)	Referencia	Precio
Simil-Piel	131x75x68 cm	CADM902	595 €

Muestrario SIMIL-PIEL. Otros colores disponibles, consultar



NEGRO (RNE)

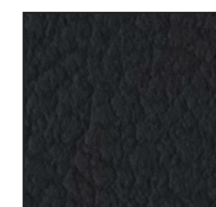

GRAFITO (RGR)

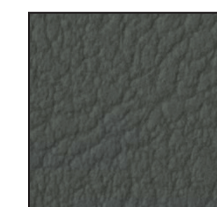

GRIS (RG)

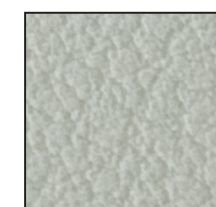

GRIS CLARO (RGC)



TAUPE (RTA)



BEIGE (RBE)

3 Plazas



Tapicería	Medidas (axfxh)	Referencia	Precio
Simil-Piel	180x75x68 cm	CADM903	752 €



ARENA (RAR)

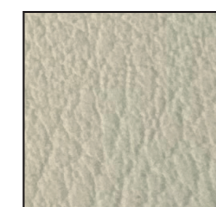

BLANCO (RBW)

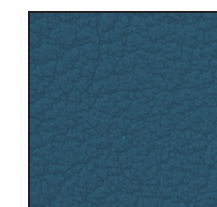

AZUL (RAZ)

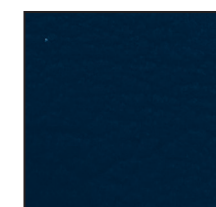

AZUL OSCURO (RAO)

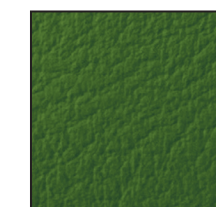

VERDE O. (RVO)

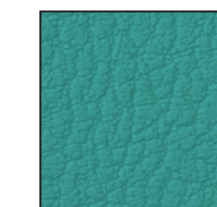

VERDE J. (RVJ)



VERDE (RVT)



MELOCOTÓN (RML)



TERRACOTA (RTE)



ROJO (RRO)



M800

1 Plaza



Tapicería	Medidas (axfxh)	Referencia	Precio
Simil-Piel	83x85x78 cm	CADM801	435 €

Mostrario SIMIL-PIEL. Otros colores disponibles, consultar

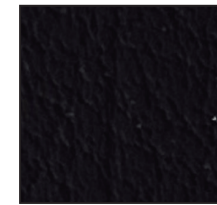

NEGRO
(RNE)



GRAFITO
(RGR)

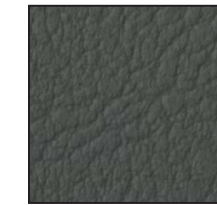

GRIS
(RG)

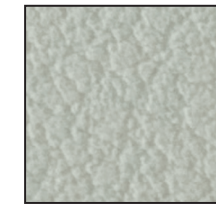

GRIS CLARO
(RGC)



TAUPE
(RTA)

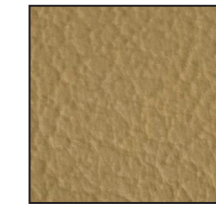

BEIGE
(RBE)



ARENA
(RAR)

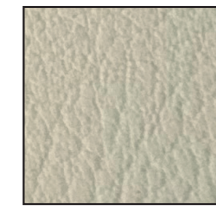

BLANCO
(RBW)

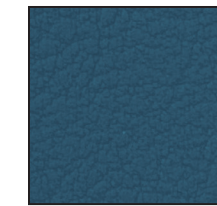

AZUL
(RAZ)



AZUL OSCURO
(RAO)

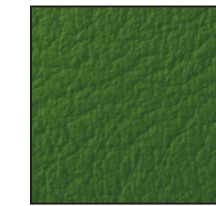

VERDE O.
(RVO)

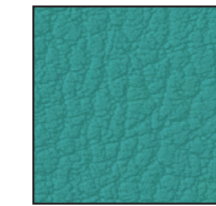

VERDE J.
(RVJ)

2 Plazas



Tapicería	Medidas (axfxh)	Referencia	Precio
Simil-Piel	136x85x78 cm	CADM802	611 €



VERDE
(RVT)



MELOCOTÓN
(RML)



TERRACOTA
(RTE)



ROJO
(RRO)

3 Plazas



Tapicería	Medidas (axfxh)	Referencia	Precio
Simil-Piel	185x85x78 cm	CADM803	772 €





ETNA

ETNA



Tapicería	Medidas (axfxh)	Referencia	Precio
1 plaza			
Tela	78x70x68 cm	PETNA1P	647 €
Simil-Piel	78x70x68 cm	PETNA1P	686 €
2 plazas			
Tela	133x70x68 cm	PETNA2P	858 €
Simil-Piel	133x70x68 cm	PETNA2P	909 €
3 plazas			
Tela	188x70x68 cm	PETNA3P	999 €
Simil-Piel	188x70x68 cm	PETNA3P	1.062 €

Especificaciones
 Patas metálicas con tubo de acero de Ø14 mm pintadas en color negro (N), blanco (B) o cromado (C).



Mesas Etna



Medidas (axfxh)	Color patas	Referencia	Precio
127x62x35 cm	Negro o blanco	PETNAMC	167 €
127x62x35 cm	Cromadas	PETNAMC	204 €
97x92x35 cm	Negro o blanco	PETNAMRI	164 €
97x92x35 cm	Cromadas	PETNAMRI	199 €
67x62x35 cm	Negro o blanco	PETNAMR	126 €
67x62x35 cm	Cromadas	PETNAMR	155 €

Especificaciones
 Patas metálicas con tubo de acero de Ø14 mm pintadas en color negro (N), blanco (B) o cromado (C) con tablero blanco (B), roble (RB) o nogal (NL).

ETNA PLEXIA



Tapicería	Medidas (axfxh)	Referencia	Precio
1 plaza			
Tela	78x70x68 cm	PETNAP1P	677 €
Simil-Piel	78x70x68 cm	PETNAP1P	716 €
2 plazas			
Tela	133x70x68 cm	PETNAP2P	888 €
Simil-Piel	133x70x68 cm	PETNAP2P	939 €
3 plazas			
Tela	188x70x68 cm	PETNAP3P	1.029 €
Simil-Piel	188x70x68 cm	PETNAP3P	1.092 €

Especificaciones
 Patas metálicas con pletina curvada de 80 mm pintadas en color negro (N) o blanco (B).



Mesas Etna Plexia



Medidas (axfxh)	Referencia	Precio
120x60x35 cm	PETNAMPL1	194 €
Ø60x35 cm	PETNAMPL2	175 €
Ø60x30 cm	PETNAMPL3	166 €

Especificaciones
 Patas metálicas con pletina curvada de 80 mm pintadas en color negro (N) y blanco (B) con tablero blanco (B) o roble (RB).

ETNA Muestrario



Muestrario TELA Basic.

NEGRO (F01)	GRIS TOPO (BGO)	GRIS (F02)	GRIS PERLA (F03)	ROJO (F04)	BURDEOS (BB)	NARANJA (BJ)	BEIGE (F06)
AMARILLO (F07)	AZUL (F08)	AZUL OSCURO (F09)	AZUL-GRIS (F10)	CELESTE (F11)	TURQUESA (F12)	VERDE (F13)	VERDE OSCURO (F14)

Muestrario TELA Cosvi.

GRIS (CG)	GRIS CLARO (CGC)	TOPO (CTO)	MARRÓN (CMA)	POWDER (CPO)	DAK BEIGE (CDB)	BEIGE (CBE)	TURQUESA (CT)
BERENJENA (CBJ)	CORAL (CCO)	ROSA (CRO)					

Muestrario SIMIL-PIEL.

NEGRO (NN)	GRIS (NG)	CHOCOLATE (NM)	POTRO (NP)	CAMEL (NCA)	ARENA (NA)	BEIGE (NBE)	BLANCO (NB)
CELESTE (NCE)	AZUL OSCURO (NAZ)	VERDE (NV)	ROJO (NR)	BURDEOS (NBU)			



SHERU

Versión 4 patas de polipropileno



Tapicería	Medidas (axfxh)	Referencia	Precio
Con topes			
Tela	59x56x75 cm	PSHE254GT	363 €
Simil-Piel	59x56x75 cm	PSHE254GT	386 €
Con ruedas			
Tela	59x56x75 cm	PSHE254GR	366 €
Simil-Piel	59x56x75 cm	PSHE254GR	389 €

Especificaciones

Giratoria con 4 patas en polipropileno negro (N) o blanco (B) con topes o ruedas de Ø50 mm.

Versión 4 patas metálicas



Tapicería	Medidas (axfxh)	Referencia	Precio
Tela	59x56x75 cm	PSHE25F	292 €
Simil-Piel	59x56x75 cm	PSHE25F	316 €

Especificaciones

Fija con 4 patas metálicas en negro (N) o blanco (B).

Versión 4 patas de aluminio



Tapicería	Medidas (axfxh)	Referencia	Precio
Con topes			
Tela	59x56x75 cm	PSHE254AT	412 €
Simil-Piel	59x56x75 cm	PSHE254AT	435 €
Con ruedas			
Tela	59x56x75 cm	PSHE254AR	415 €
Simil-Piel	59x56x75 cm	PSHE254AR	438 €

Especificaciones

Giratoria en aluminio pintado en negro (N) o blanco (B) con topes o ruedas de Ø50 mm.

Versión 4 patas de madera



Tapicería	Medidas (axfxh)	Referencia	Precio
Tela	59x56x75 cm	PSHE25FM	349 €
Simil-Piel	59x56x75 cm	PSHE25FM	374 €

Especificaciones

Fija con 4 patas de madera en roble (RB) o roble oscuro (RBO).

SHERU Muestrario



Muestrario TELA Basic.

NEGRO (F01)	GRIS TOPO (BGO)	GRIS (F02)	GRIS PERLA (F03)	ROJO (F04)	BURDEOS (BB)	NARANJA (BJ)	BEIGE (F06)
AMARILLO (F07)	AZUL (F08)	AZUL OSCURO (F09)	AZUL-GRIS (F10)	CELESTE (F11)	TURQUESA (F12)	VERDE (F13)	VERDE OSCURO (F14)

Muestrario TELA Cosvi.

GRIS (CG)	GRIS CLARO (CGC)	TOPO (CTO)	MARRÓN (CMA)	POWDER (CPO)	DAK BEIGE (CDB)	BEIGE (CBE)	TURQUESA (CT)
BERENJENA (CBJ)	CORAL (CCO)	ROSA (CRO)					

Muestrario SIMIL-PIEL.

NEGRO (NN)	GRIS (NG)	CHOCOLATE (NM)	POTRO (NP)	CAMEL (NCA)	ARENA (NA)	BEIGE (NBE)	BLANCO (NB)
CELESTE (NCE)	AZUL OSCURO (NAZ)	VERDE (NV)	ROJO (NR)	BURDEOS (NBU)			



CHELSEA 800

Versión 4 patas de poliamida



Tapicería	Medidas (axfxh)	Referencia	Precio
Tela	Ø68x81 cm	PCHE8GT	295 €
Simil-Piel	Ø68x81 cm	PCHE8GT	326 €

Especificaciones

Giratoria con 4 patas de poliamida en negro (N) o blanco (B).

Versión 4 patas metálicas



Tapicería	Medidas (axfxh)	Referencia	Precio
Tela	59x57x79 cm	PCHE8F	224 €
Simil-Piel	59x57x79 cm	PCHE8F	255 €

Especificaciones

Fija con 4 patas metálicas en negro (N) o blanco (B).

Versión 4 radios de aluminio



Tapicería	Medidas (axfxh)	Referencia	Precio
Tela	Ø67x71-87 cm	PCHE8GC	266 €
Simil-Piel	Ø67x71-87 cm	PCHE8GC	297 €

Especificaciones

Giratoria con elevación en altura con 4 radios de aluminio pulido.

Versión 4 patas de madera



Tapicería	Medidas (axfxh)	Referencia	Precio
Tela	59x57x79 cm	PCHE8FM	283 €
Simil-Piel	59x57x79 cm	PCHE8FM	326 €

Especificaciones

Fija con 4 patas de madera.

CHELSEA 800 Muestrario



Muestrario TELA Basic.

NEGRO (F01)	GRIS TOPO (BGO)	GRIS (F02)	GRIS PERLA (F03)	ROJO (F04)	BURDEOS (BB)	NARANJA (BJ)	BEIGE (F06)
AMARILLO (F07)	AZUL (F08)	AZUL OSCURO (F09)	AZUL-GRIS (F10)	CELESTE (F11)	TURQUESA (F12)	VERDE (F13)	VERDE OSCURO (F14)

Muestrario TELA Cosvi.

GRIS (CG)	GRIS CLARO (CGC)	TOPO (CTO)	MARRÓN (CMA)	POWDER (CPO)	DAK BEIGE (CDB)	BEIGE (CBE)	TURQUESA (CT)
BERENJENA (CBJ)	CORAL (CCO)	ROSA (CRO)					

Muestrario SIMIL-PIEL.

NEGRO (NN)	GRIS (NG)	CHOCOLATE (NM)	POTRO (NP)	CAMEL (NCA)	ARENA (NA)	BEIGE (NBE)	BLANCO (NB)
CELESTE (NCE)	AZUL OSCURO (NAZ)	VERDE (NV)	ROJO (NR)	BURDEOS (NBU)			



BOOL

Versión base metálica respaldo bajo



Tapicería	Medidas (axfxh)	Referencia	Precio
Tela	65x75 cm	PBOLBP	395 €
Simil-Piel	65x75 cm	PBOLBP	419 €

Especificaciones

Fija con base metálica en color negro (N) o blanco (B).

Versión 4 patas de madera



Tapicería	Medidas (axfxh)	Referencia	Precio
Tela	65x75 cm	PBOLBM	506 €
Simil-Piel	65x75 cm	PBOLBM	529 €

Especificaciones

Fija con 4 patas de madera.

Versión base metálica respaldo alto



Tapicería	Medidas (axfxh)	Referencia	Precio
Tela	65x106 cm	PBOLAP	486 €
Simil-Piel	65x106 cm	PBOLAP	514 €

Especificaciones

Fija con base metálica en color negro (N) o blanco (B).

Versión 4 patas de madera



Tapicería	Medidas (axfxh)	Referencia	Precio
Tela	65x106 cm	PBOLAM	596 €
Simil-Piel	65x106 cm	PBOLAM	624 €

Especificaciones

Fija con 4 patas de madera.



Muestrario TELA Basic.

NEGRO (F01)	GRIS TOPO (BGO)	GRIS (F02)	GRIS PERLA (F03)	ROJO (F04)	BURDEOS (BB)	NARANJA (BJ)	BEIGE (F06)
AMARILLO (F07)	AZUL (F08)	AZUL OSCURO (F09)	AZUL-GRIS (F10)	CELESTE (F11)	TURQUESA (F12)	VERDE (F13)	VERDE OSCURO (F14)

Muestrario TELA Cosvi.

GRIS (CG)	GRIS CLARO (CGC)	TOPO (CTO)	MARRÓN (CMA)	POWDER (CPO)	DAK BEIGE (CDB)	BEIGE (CBE)	TURQUESA (CT)
BERENJENA (CBJ)	CORAL (CCO)	ROSA (CRO)					

Muestrario SIMIL-PIEL.

NEGRO (NN)	GRIS (NG)	CHOCOLATE (NM)	POTRO (NP)	CAMEL (NCA)	ARENA (NA)	BEIGE (NBE)	BLANCO (NB)
CELESTE (NCE)	AZUL OSCURO (NAZ)	VERDE (NV)	ROJO (NR)	BURDEOS (NBU)			



FLOWER

Versión 4 radios de aluminio



Tapicería	Medidas (axfxh)	Referencia	Precio
Base fija			
Tela	72x60x90 cm	U55FLOCF	296 €
Simil-Piel	72x60x90 cm	U55FLOCF	306 €
Base giratoria			
Tela	72x60x90 cm	U55FLOCG	296 €
Simil-Piel	72x60x90 cm	U55FLOCG	306 €

Versión 4 patas de madera



Tapicería	Medidas (axfxh)	Referencia	Precio
Tela	72x60x90 cm	U55FLOM	333 €
Simil-Piel	72x60x90 cm	U55FLOM	343 €

Muestrario TELA

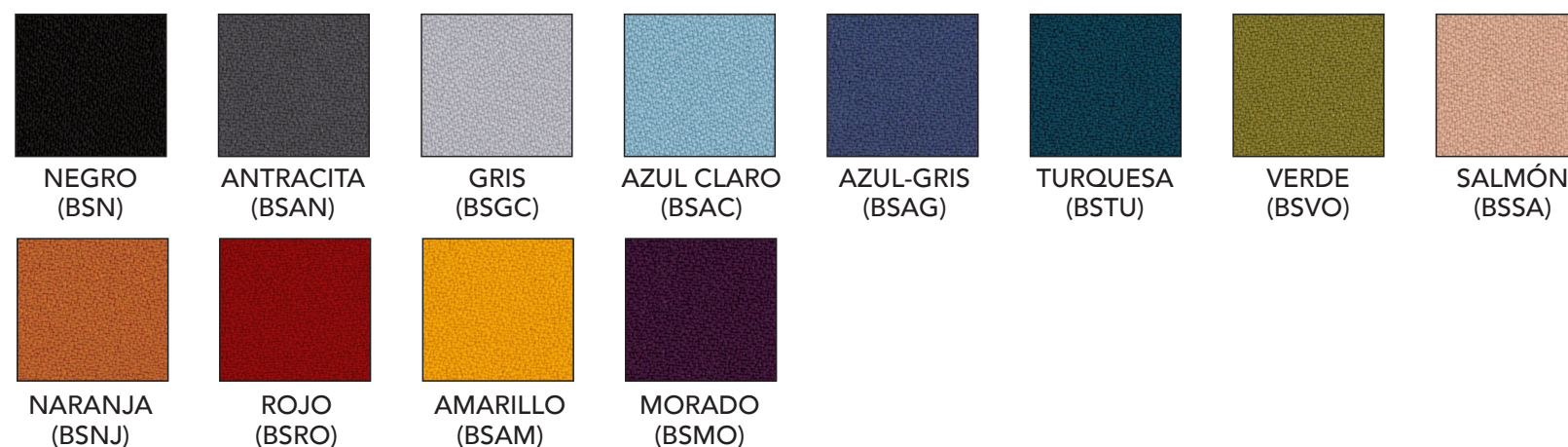

Muestrario SIMIL-PIEL





SLASTIC

Módulo recto



Tapicería	Medidas (axfxh)	Referencia	Precio
Tela	60x68x77 cm	DILSLAR	373 €
Simil-Piel	60x68x77 cm	DILSLAR	399 €

Elementos opcionales - revistero



Descripción	Referencia	Precio
Revistero	DILSLARV	36 €

Módulo curvo



Tapicería	Medidas (axfxh)	Referencia	Precio
Exterior			
Tela	83x68x77 cm	DILSLACE	391 €
Simil-Piel	83x68x77 cm	DILSLACE	421 €
Interior			
Tela	83x68x77 cm	DILSLACI	391 €
Simil-Piel	83x68x77 cm	DILSLACI	421 €

Muestrario TELA. Otros colores disponibles, consultar

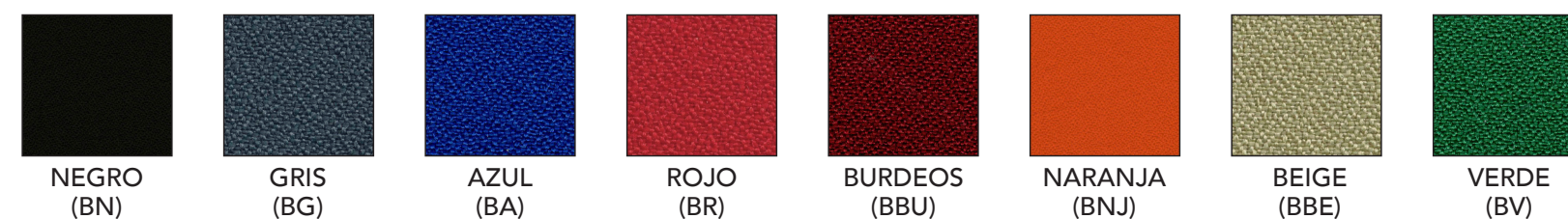

Muestrario SIMIL-PIEL. Otros colores disponibles, consultar

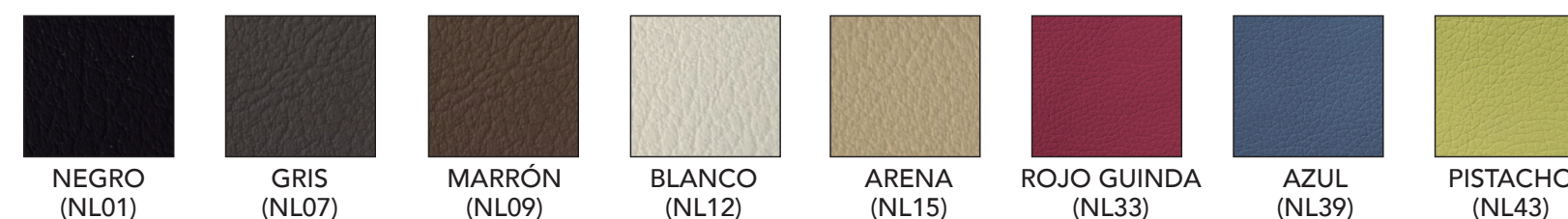

Elementos opcionales - brazo



Tapicería	Referencia	Precio
Tela	DILSLAB	76 €
Simil-Piel	DILSLAB	81 €



*Showroom - Calle Ramón y Cajal 2 nave 5,
entrada por calle Puig Adam, Leganés - Madrid.*

Teléfono - 916 939 391

WhatsApp - 638 287 770

Email - ventas@officedeco.es

www.officedeco.es