

PONI







Especificaciones técnicas

- 1 Estructura de acero redondo de diámetro 45 mm con ruedas para facilitar el desplazamiento de la mesa.
- 2 Tapa con sistema abatible en compacmel de 13 mm de grosor con aristas redondeadas.

Muestrario patas.

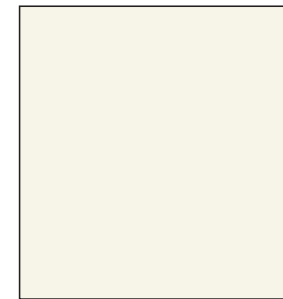

BLANCO
(B)



NEGRO
(N)

Muestrario tablero.



BLANCO
(B)



NEGRO
(N)

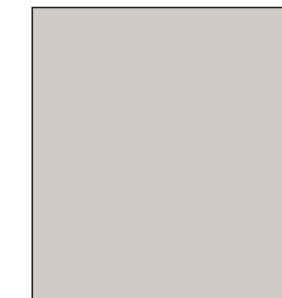

GRIS
(G)

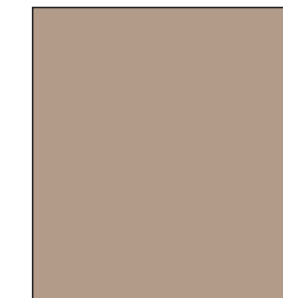

TIERRA
(TI)



AZUL
(AZ)

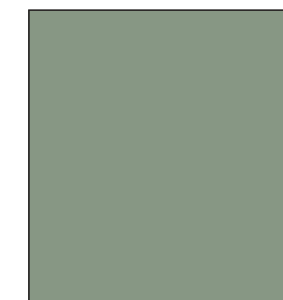

VERDE OLIVA
(VO)

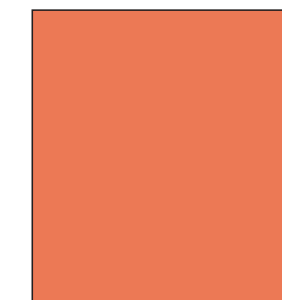

TERRACOTA
(TE)

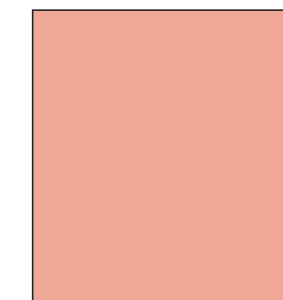

ROSA
(RS)

Mesa individual.

Dimensiones	Referencia	Precio
70x55x74 cm	IMAPONM01	239 €

Pedido mínimo 4 unidades (mismo color)

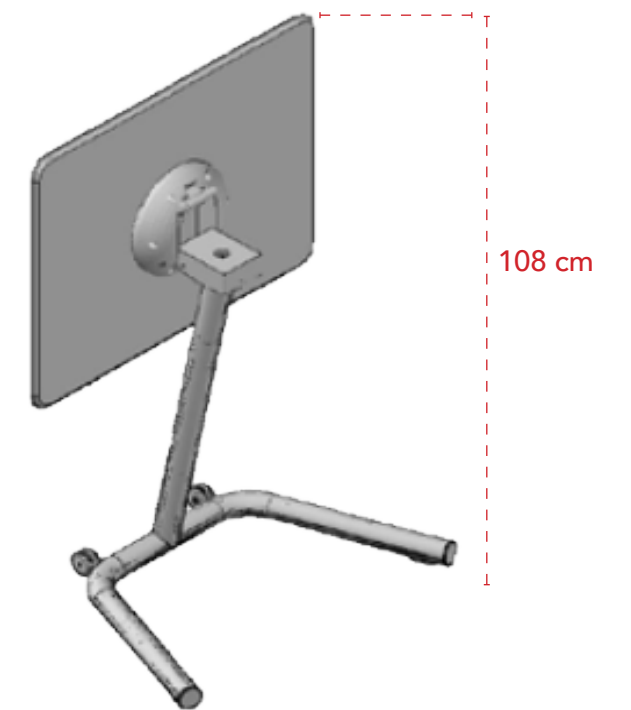



Showroom - Calle Ramón y Cajal 2 nave 5,
entrada por calle Puig Adam, Leganés - Madrid.

Teléfono - 916 939 391

WhatsApp - 638 287 770

Email - ventas@officedeco.es

www.officedeco.es